

AD90



Transponder Duplicating System

Operating Manual

**ADVANCED
DIAGNOSTICS**

Operating Manual

Transponder Key Duplicator—AD90

CONTENTS

	PAGE
1.0 GENERAL INFORMATION	1
2.0 GENERAL OPERATION	2
3.0 CRYPTO TRANSPONDER INTERFACE	5
4.0 PC PROGRAM OPERATION	10
5.0 TRANSPONDER INFORMATION	13
6.0 TRANSPONDER TYPES	14
7.0 SOFTWARE UPDATING	15
8.0 SPECIFICATION	16

1.0 GENERAL INFORMATION

The professional duplicating machine, AD90, has been designed and built to keep pace with the constant evolution of transponder car keys.

The AD90 key duplicator features the most innovative electronic components in the field of radio frequencies thus allowing easy detection, reading and cloning (duplication) of fixed code transponders and the identification of cryptographic transponder codes.

The AD90 in addition has major features such as copying of Crypto 42 type transponders and the Texas 4C and 4D transponders. These are additional options but make the AD90 a powerful tool.

Features:

- Read transponder
- Write onto transponder
- Copy transponder
- Software update from Internet
- Usable with PC software
- Available to be used with the 'Chip Decoder System'
- Adaptable to future projects.
- Wide range menu language

AD90 can detect, read and duplicate (using an appropriate key blank) Philips, Megamos, Temic and Texas transponders:

Reads fixed code transponders:

- Philips® PCF7930/31 - Silca® 33, 73
- Philips® PCF7935 40,41,42,44,45
- Temic®-Silca® 11 i 12
- Megamos® - Silca® 13
- Silca® T5
- Texas® - Silca® 4C

Recognises:

- Megamos® crypto - Silca® 48,
- Philips® crypto - Silca® 46,
- Texas crypto 4D,
- Fixed 11, 12, 13, 33, 73, 4C, T5
- Crypto 40, 41, 42, 44, 45, 4D, 48
- Rolling + Crypto 46

Copies:

- 11, 12 Temic
- 13 Megamos
- 33, 73 Philips
- 4C Texas
- 4D Texas crypto
- T5 Nova

2.0 GENERAL OPERATION

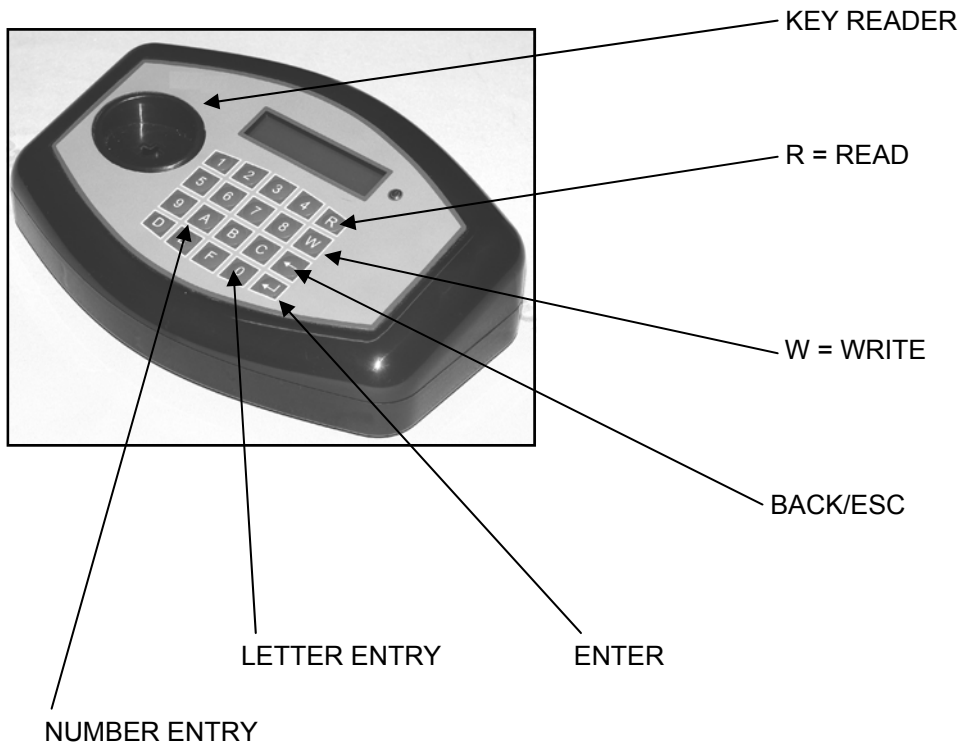

DETECTING THE PRESENCE OF A TRANSPONDER

NOTE: This function can be used for:

- Philips 40-41-42-44-45
- Temic 11-12
- Megamos 13

0000000000000000
TYP:

1. Switch to 'TEST' mode by pressing the 'A' button.

TEST

2. The LCD indicates the presence of a transponder.

< TRANSPONDER! >
TEST

NOTE : 'TEST' does not detect Texas transponders and Philips HITAG 2 (PCF7936 in crypto mode).

After testing, press the ESC button to return to 'READ' mode.

2.0 GENERAL OPERATION

READING

1. Insert key into the key reader.

0000000000000000
TYP:

2. Press the 'R' button.

12223344556677788
READ

3. The transponder information will be displayed.

12223344556677788
128 TYP : 33

NOTE: If the transponder is locked 'LCK' is displayed in the bottom left corner.

WRITING

1. Insert key/transponder to write into the key reader and press the 'W' button

12223344556677788
128 TYP : 33

2. Select the required transponder by pressing the relevant number on the AD90.

12223344556677788
1-PH 2-T5 3-ESC

12223344556677788
1-TEXAS 3-ESC

12223344556677788
WRITE

12223344556677788
VERIFY

12223344556677788
SUCCESS

3. If 'WRITE ERROR' is displayed check the transponder type and try again.

12223344556677788
WRITE ERROR

2.0 GENERAL OPERATION

WRITING WITH THE KEYPAD

1. Clear display by pressing 'R' with no transponder in the key reader.

0000000000000000
TYP:

2. Insert the key/transponder to be written into the key reader.

3. Select required transponder type by pressing the 'W' button then press 'ENTER' to confirm.

TYP:11 2-CHANGE
3-ESC 4-OK

4. Type in the required code - press the 'W' button to move the cursor to the right and the 'R' button to move the cursor to the left.

0000000000000000

5. Press 'ENTER' then press 'W'.

6. Select the required transponder by pressing the relevant number on the AD90.

12223344556677788
1-PH 2-T5 3-ESC

12223344556677788
1-TEXAS 3-ESC

12223344556677788
WRITE

12223344556677788
VERIFY

12223344556677788
SUCCESS

7. If 'WRITE ERROR' is displayed check the transponder type and try again.

12223344556677788
WRITE ERROR

3.0 CRYPTO TRANSPONDER INTERFACE

The Crypto Transponder Interface can be used in conjunction with the AD90 to copy first generation Philips crypto transponders (type 42) fitted to VAG group vehicles.

Transponder part numbers:

- Advanced Keys - AKTP3
- Elme Tools - CRTP101
- Key Line - TK10
- Silca - T10
- JMA - TP10

Vehicles fitted with this type of transponder:

Model	Years	AD90 ID
VOLKSWAGEN		
Caddy	99-00	42
Golf Cabrio	98>	42
Lupo	98-00	42
Polo	98-00	42
Sharan	98-00	42
Transporter	98-00	42
SEAT		
Arosa	99-01	42
Cordoba Vario	99>	42
Ibiza	98-02	42
Inca	98-00	42
FORD		
Galaxy	98-00	42

3.0 CRYPTO TRANSPONDER INTERFACE

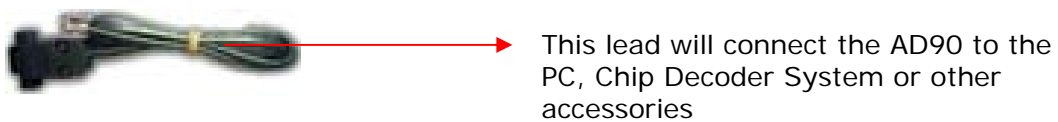
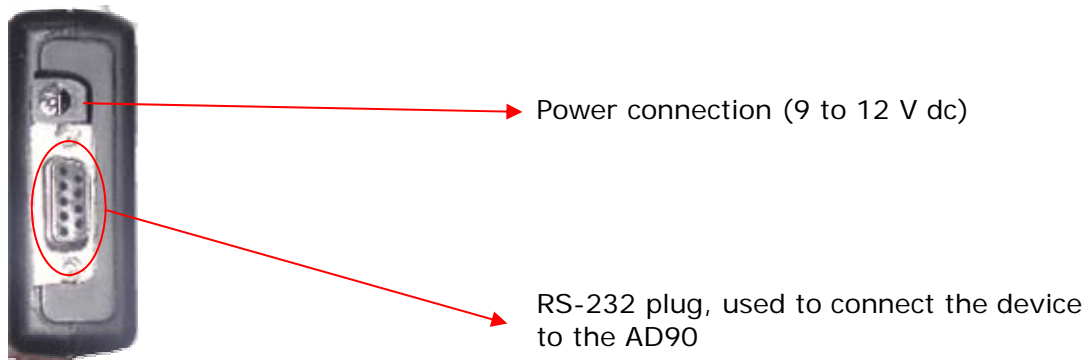
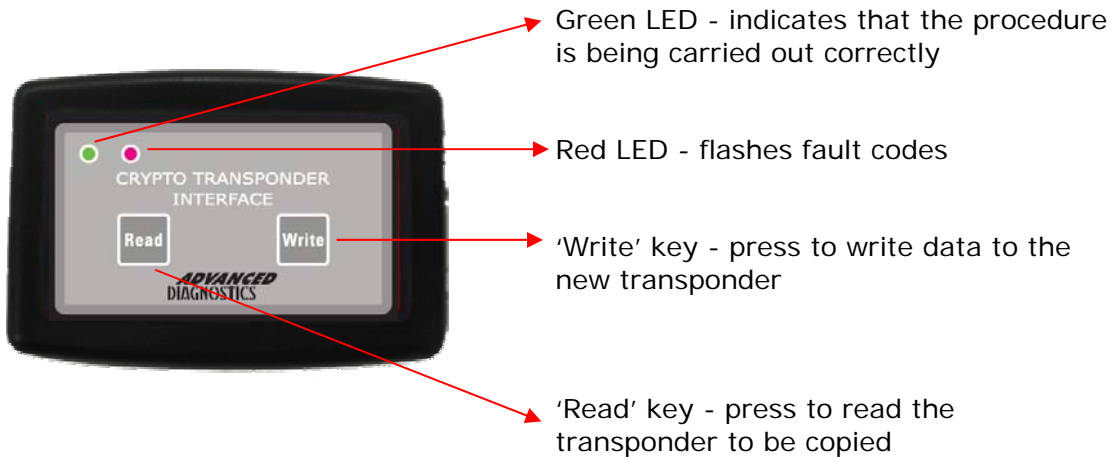

3.0 CRYPTO TRANSPONDER INTERFACE

NOTE: Before starting the copying procedure, please make sure that your AD90 software version is 3.14 or higher. If not please contact your distributor for assistance.

Connect the hardware together as shown below.

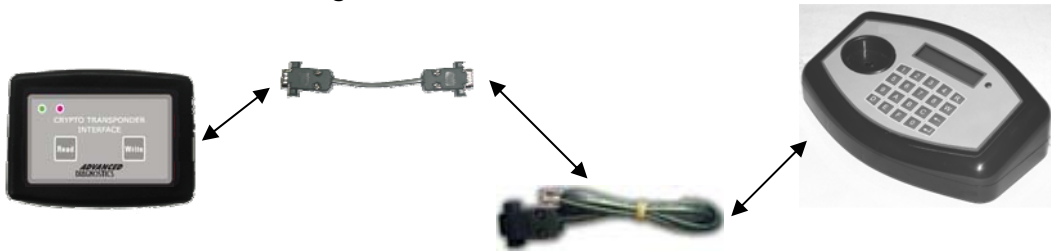

1. Connect the power supplies to the AD90 and the Crypto Transponder Interface. The green and red LEDs will illuminate for one second and then extinguish.

NOTES:

- i) If non-original power supplies are used for the AD90 or the Crypto Transponder Interface the warranty will be invalid.
 - ii) Please check that there is nothing that may short circuit the devices when they are connected to the power supplies.
2. Insert the key into the AD90 key reader.
 3. Press the 'Read' key on the Crypto Transponder Interface, the green LED will illuminate and will remain on throughout the reading procedure.
 4. Once the transponder code has been recorded, the green LED will start to flash. Remove the original transponder from the AD90 and insert the new transponder/key into the AD90 key reader.
 5. Press the 'Write' key on the Crypto Transponder Interface, the green LED will illuminate and will remain on throughout the writing procedure.
 6. Once the copying procedure is completed, the green LED will extinguish and the key/transponder can be removed from the key reader.

3.0 CRYPTO TRANSPONDER INTERFACE

If a problem is detected, the red LED will indicate a fault code by blinking. The number of times the LED blinks denotes what the fault code is, please refer to the chart below:

Blinks	Description
1	Communication error Check all connections and make sure devices are on
2	Transponder not found Check that the transponder is in the AD90 key reader
3	Wrong transponder. Swap it to a PHILIPS PCF 7935 / 79935, 42 ID
4	Wrong transponder data The transponder seems to be OK but the data does not meet the Philips 42 standard
5	Incorrect command to the AD90 Disconnect and re-connect all devices
6	Wrong AD90 software version Version must be 3.14 or higher
7	Wrong data sent by AD90 Repeat the procedure
8	Time Out You took too long to press a key
9	Transponder cannot be decrypted Contact your distributor
10	Not enough memory Data too large, use a different transponder and repeat procedure
11	Incorrect transponder data The transponder seems to be OK but the data does not meet the Philips 42 standard
12	Wrong data sent to AD90 Repeat the procedure
13	Communication error Check all connections and make sure devices are on
14	Communication error to AD90 Check all connections and make sure devices are on

3.0 CRYPTO TRANSPONDER INTERFACE

Blinks	Description
15	Data received is corrupted Check all connections and make sure devices are on
16	Hardware not found or faulty Check all connections and make sure devices are on
17	Invalid internal communications Problems with data decrypting
18	Invalid internal communications Problems on data decrypting
19	Fatal error Contact your distributor

4.0 PC PROGRAM OPERATION

WINDOWS PC PROGRAM

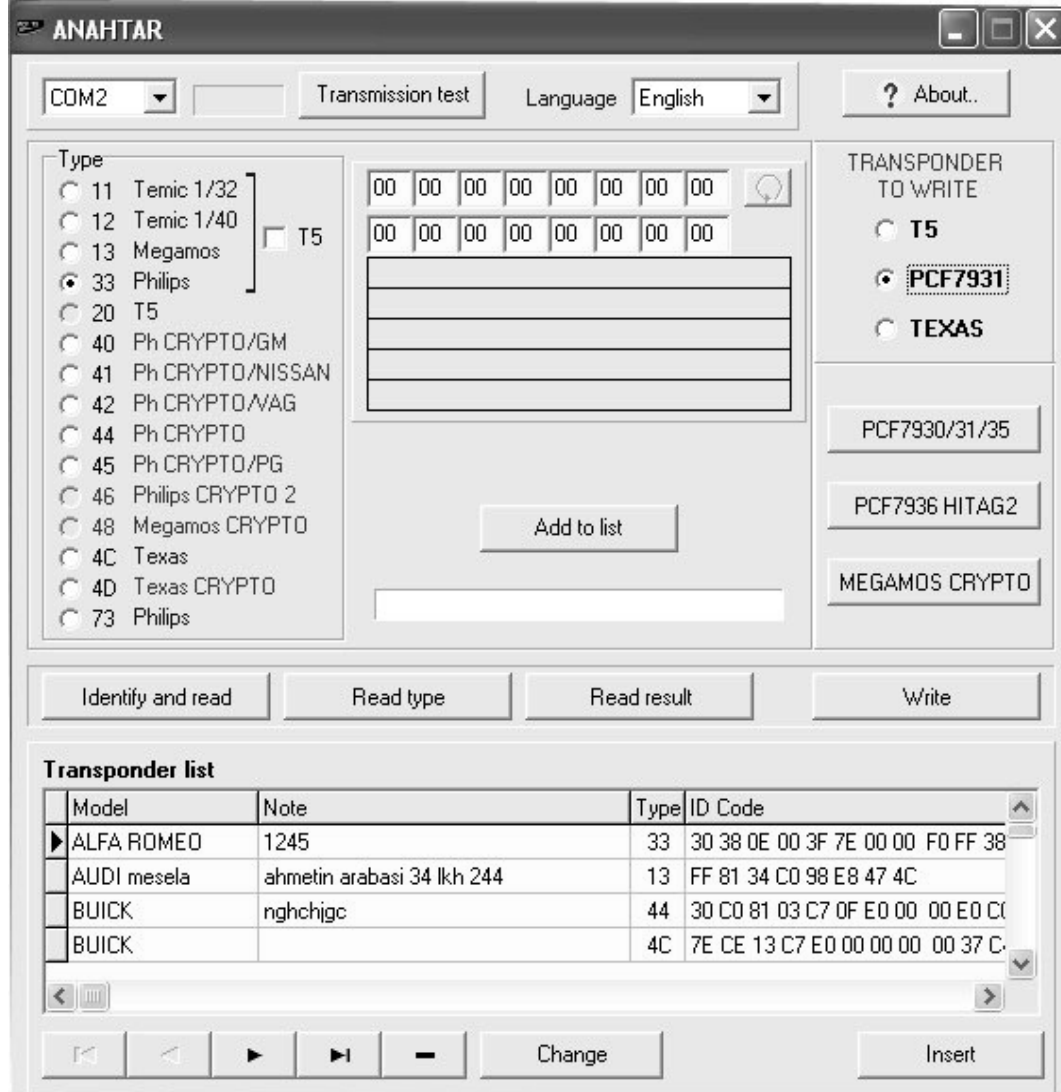

Program functions:

- Identify and read - read transponder, identify type and ID code.
- Read type - read selected type transponder.
- Read result – read result from programmer, last type and ID code.
- Write - write code to transponder PCF/T5/Texas - code and transponder type may be inserted manually.
- Add to list – add transponder parameters to database list.
- Insert – insert transponder parameters from database list to main window.
- Change – change database record.

4.0 PC PROGRAM OPERATION

WINDOWS PC PROGRAM

Function PCF7930/31

Write

Format – Write bytes to access control memory PCF7930/31 - blocks 0 and 1
RB1 (read block 1) always read block 1 before the others.

RFB (read first block) number of first block to read.

RLB (read last block) number of last block to read.

BWP (block write protection) set write protection: MSB for block 0, LSB for block 7.

Program – write to transponder.

Byte/Block - Write string of bytes: block number (0-7), bytes (0-F) – hex.

ATTENTION!

Be careful while writing blocks 0 and 1. These blocks store information for access control.

Program – write to transponder.

Save – save to file.

The screenshot shows the 'PCF7930/31/35' software window. It is divided into 'Write' and 'Read' sections.

Write Section:

- Format:** Includes checkboxes for 'RFB1 Read Block 1' (checked), 'PAC Password CheckBit', 'BWP Block Write Protection' (set to 00), 'RFB Read First Block' (set to 0), and 'RLB Read Last Block' (set to 7). A 'Program' button is present.
- Byte / Block:** A 'Block number' dropdown is set to 1. Below it is a grid for writing bytes (00-0F) for blocks 0-7. The '01' and '07' bytes are highlighted. A 'Program' button is to the right.
- Password:** A 'Password' checkbox is unchecked, with a field containing '00 00 00 00 00 00 00'.
- A 'Program format and block + read' checkbox is checked.

Read Section:

- A table displays data for blocks 0-7. The columns are labeled 0 through F. The data for block 0 is highlighted.
- Buttons for 'Read', 'Save', and 'Open' are on the right.
- A 'Blocks' dropdown is set to 8.

4.0 PC PROGRAM OPERATION

WINDOWS PC PROGRAM

Open – read from file.

Program format and block + read – write format , block (string of bytes) and read data from transponder.

It is recommended to verify the transponder after writing procedure.











Read from transponder number of blocks. Number of blocks – number of blocks to read.

Read – read from transponder.







Save – save block to file. Open – read block from file.

Using right mouse button it is possible to store block in field write->byte/block.

5.0 TRANSPONDER INFORMATION

ID	TRANSPONDER		IDENTIFY	READ	WRITE
11	TEMIC 1/32		YES	YES	T5
12	TEMIC 1/40		YES	YES	T5
13	MEGAMOS		YES	YES	T5
20	SILCA T5		YES		
33	PHILIPS PCF7930/31		YES	YES	T5 PCF7930/31
44	PHILIPS CRYPTO PCF7935		YES	YES (ID code)	T5 PCF7930/31 (ID code)
46	PHILIPS CRYPTO2 PCF7936		YES		
48	MAGAMOS CRYPTO		YES		
4C	TEXAS		YES	YES	KEYLINE
4D	TEXAS CRYPTO		YES	YES (ID code)	
73	PHILIPS PCF7930/31 MULTIPLY BLOCK		YES	YES	PCF7930/31

6.0 TRANSPONDER TYPES

ID	TYPE	DESCRIPTION	SYMBOL
PH00	PHILIPS	FIXED CODE	
PH10		CRYPTO	
PH1A		CRYPTO FOR OPEL	
PH1B		CRYPTO FOR NISSAN - FORD	
PH1C		CRYPTO FOR VAG	
PH1D		CRYPTO FOR PEUGEOT	
PH20		CRYPTO 2 FOR PSA - FIAT - FORD	
TM10	TEMIC	FIXED CODE FOR FIAT	
TM20		FIXED CODE FOR MAZDA	
MG00	MEGAMOS	FIXED CODE	
MG10		CRYPTO FOR VAG	
TX00	TEXAS	FIXED CODE	
TC01		CRYPTO FOR FORD - NISSAN	
TC02		CRYPTO	
TC03		CRYPTO FOR FORD	
TC04		CRYPTO FOR OPEL - RENAULT SUBARO - HYUNDAI - LINCOLN - CHRYSLER - JEEP - DODGE - EAGLE	
TC05		CRYPTO FOR FORD	
TC06		CRYPTO FOR FORD	
TP01		CRYPTO W1 FOR FORD	

7.0 SOFTWARE UPDATING

It is important to check the Advanced Diagnostics website regularly to ensure that you have the latest version of the AD90 software:

www.advanced-diagnostics.co.uk

8.0 SPECIFICATION

MACHINE DIMENSIONS	
Width	200 mm
Height	70 mm
Depth (Length)	150 mm
Weight	0,9 kg
POWER SUPPLY	
External power supply	100/250 V - 47/63 Hz
Absorption	0,3 A
Type of power supply unit	9 to 12volts
TECHNOLOGY FEATURES	
Field frequency of key insertion slot	125 kHz
Interface	Serial port RS232 & USB
Working temperature	-5°C to 40°C